

SAFETY COVER INSTALLATION MANUAL

Rectilinear Pools

(Rectangle, Grecian, True/Lazy L, Modified Oval, Roman, etc.)

Installing a safety cover is best accomplished by two or more people.

Be certain that the water level is not more than 12" below the deck. A greater distance will void the warranty. See a pool equipment supplier for skimmer covers and other devices that will allow the water to be left at a higher level.

1. Remove any obstructions that were not accounted for in the covers design and manufacture. Non-removable objects may be accommodated by using a Y-Strap assembly, Coated Stainless Cable assembly or Reduced Deck Mounting (RDM) system. (See your supplier for details.) If the cover has one or more cutouts for obstacles such as diving platforms, slide legs, waterfalls, raised ladder sockets or rock formations, the cover must first be attached at those points.
2. Find the center of the pool at each end. Using a chalk line, mark the center line out 3-4 feet from each end of the pool onto the deck.
 - 2a. For any geometric covers not containing a center web, follow the installation instructions for freeform pools.
3. Place the cover on the deck at the shallow end of the pool and spread it, right side up, over the pool as shown on the box lid. Place one spring about halfway onto each center strap. Pull the springs and straps tight to determine how far back from the pool's edge the anchors should be placed. The distance is usually about 30" from the edge of the pool, though it may vary with the amount of overlap and the fastening system being used. Once the correct measurement is determined, mark a point on the deck at that distance from the pool's edge near the intersection with each perpendicular wall. Strike a chalk line on the deck between those points to establish a line parallel to that edge of the pool. Use the same technique along the other walls of the pool, making sure that the cover overlaps the deck equally. Take particular care on pools with steps. Some step shapes will cause the overlap at the

step to be greater than the overlap at the wall on which the step(s) may be placed. Be sure that the cover is pulled tight and the springs are adjustable in both directions. If an anchor is too close to the pool, proper tensioning will not be possible and the cover will sag and may not drain properly. Once the center strap anchor positions of the end walls have been determined, transfer the distance between the remaining strap locations to each chalk line on the deck. Do so by working from the center strap and alternating from side to side. Use the same process on the sides of the pool, always beginning at the center of each wall. Do not locate or drill corner strap anchors until the ends and sides are installed.

Tips:

Place weights (use water bags, sandbags or 5 gallon pails filled with water) at the corners of the cover and as necessary around the perimeter to hold the cover in place. If the deck texture is rough, place padding between the cover and the deck to protect the cover from abrasion when shifting the cover is necessary. Rough decks may require permanent placement of a special pad under the cover to protect it. Keeping the straps tight will also minimize abrasion by restricting movement of the cover. On decks less than 36" wide or in corner or step areas, it may be necessary to place anchors beyond the deck area by using lawn tubes or stakes. The RDM system is also an option when decks are less than 36" wide. See photo below.

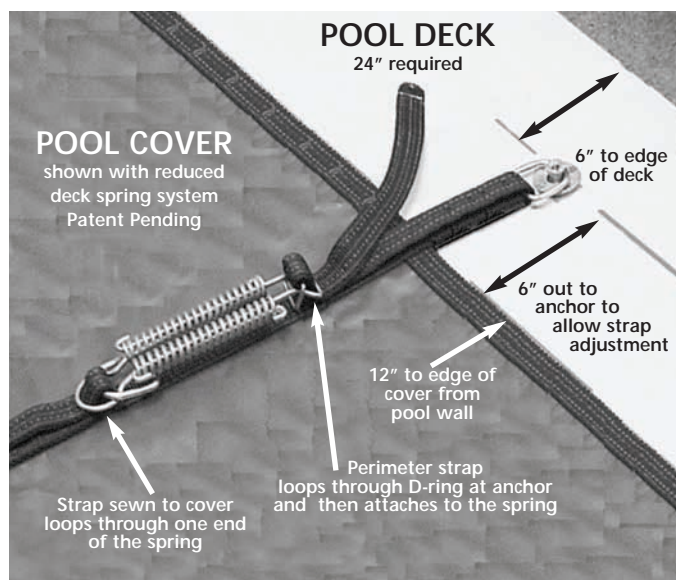

- As the straps cross the chalk line, pull them in a straight line or angled just slightly toward the nearest corner. Doing so helps keep the perimeter of the cover flat against the deck. The point at which the strap crosses the chalk line is where the anchor hole should be marked and located.
- Remember that any cutout position(s) must be identified first and their strap locations referenced to a chalk line. Set the depth of the anchor hole by wrapping tape at a distance from the tip of the masonry bit that corresponds to the length of the anchor body. The depth can also be checked by inserting the anchor installation pin (also known as a "tamp tool") up side down into the hole; the shoulder of the tool must be just below the deck level. Use a hammer drill with a long, 3/4" diameter masonry bit to drill all the holes. Drill holes at all the end and side anchor positions. Do not drill the corner anchor holes at this time.

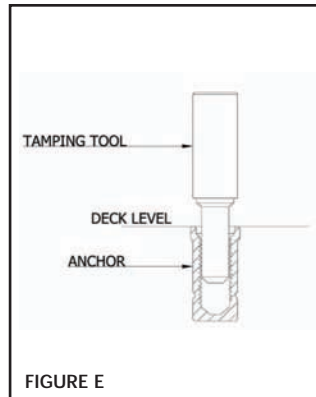

- Vacuum all dust and debris from the holes and surrounding areas, allowing the anchors to be set flush with the deck. If drilling has caused the perimeter of the hole to chip, brass and anchor collars (escutcheons) are available to cover the damage. Use the installation pin to set the external body of an anchor into each center strap hole. **(See figure E).** Then thread a lubricated insert into each anchor body leaving the unthreaded portion above the level of the deck. Silicone spray is recommended for lubrication and should also be applied following annual anchor cleaning with pressurized water.

- See the proper strap weaving method in the illustrations below. **Illustration "A"** shows the correct installation of a cover strap when using the D-ring. Please note that while the D-ring spring is standard on all covers, buckles may be ordered and used with the D-ring assembly. **Illustration "B"** shows the way in which the D-ring can be bypassed and the buckle used as an alternative means of securing a strap

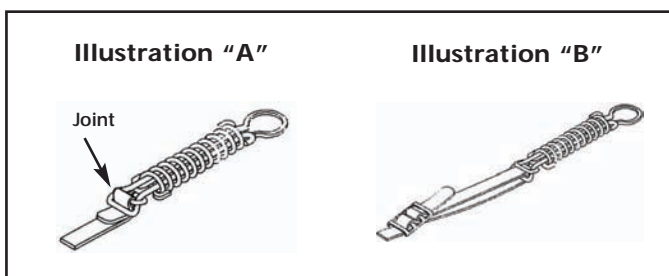

- Attach a spring to each end and side strap. A cover will fit much better if both ends of the cover are centered and anchored before moving to the sides. Using the installation rod, start at the center of each end, alternating in sequence from the center straps and attach each spring as shown in the illustration below. Attach the side springs next. Attach each step cover spring last. *Detaching the springs when the cover is removed is accomplished by reversing the installation process. Do not kick or in any way abuse the springs upon removal. Failure to use the rod voids the warranty.*

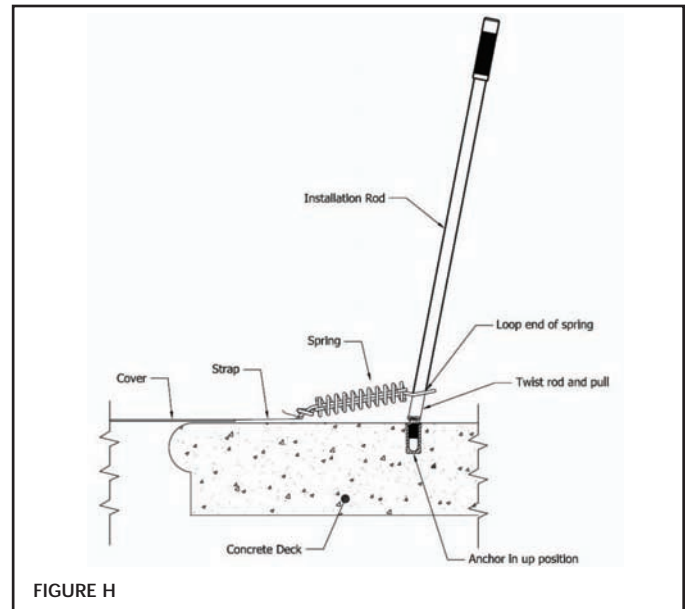

- Adjust all straps for proper tension. Each spring should be compressed about 50% or slightly less. The main objectives are to ensure equal overlap and promote direction of water toward the cover's drainage system. The cover's edges must be flat on the deck upon completion of the installation.
- The cover's corner anchor positions can now be located and drilled. It may be necessary to place them at a slight angle. That will allow the properly tensioned corner straps to draw the cover into a wrinkle-free position that promotes drainage. *Check spring tension and alignment throughout the cover season. Although springs have been properly positioned and tensioned upon installation, it is equally important to adjust them while snow, rain and debris have their cumulative effect. Uniform spring tensioning will prevent puddles from forming leading to damage to the cover. Be sure that the cover's edge is the same all around the pool.*

Homeowners must be shown the care and safety instructions on the cover labels!

Freeform Pools

(Kidney, Mtn. Lake/Pond, Lagoon, etc.)

Freeform safety covers can be installed following the same guidelines as those for rectilinear covers; however, their configurations make the use of chalk lines unlikely for locating anchor positions.

1. Freeform covers are designed to provide about 1½ times the overlap of rectilinear covers. As a result, their anchors are placed approximately 18" back from the cover's edge. Find the centermost strap of the cover and position it such that the cover overlaps the pool's perimeter equally. If non-removable obstacles exist, the cover should be positioned and attached first at those points. Use weights to hold the cover in place as suggested in the "Tips" section of this manual. Effective weighting of Freeform covers is essential to their proper installation.
2. Attach springs to each end of the center length (end) strap and as shown in **illustrations A and B**. Mark the anchor locations approximately 18" back from the edge of the cover with the straps pulled tight. Drill the holes, vacuum and set the anchors as described previously. Attach the springs to the anchors and tension them properly. Be sure the overlap is equal on each end. Alternating from the center strap, repeat this procedure for all length (end) straps.
3. Find the center width (side) strap and attach springs to each end. Mark the anchor locations approximately 18" back from the edge of the cover while tension is applied across the strap. Drill the holes, vacuum and set the anchors as described. Attach the springs and tension them properly. Repeat with each width strap alternating from the center out.
4. Once all anchors and springs are in place, adjust the tension equally on all springs making sure the cover lies perfectly flat. Check spring compression and cover drainage periodically throughout the season. Homeowners must be shown the care and safety instructions on the cover labels.

Installing anchors in surfaces other than concrete.

(Pavers, brick and stone)

It is not uncommon for pavers, brick or stone to be dry set on a bed of sand. In order to secure a safety cover to materials such as these, it is necessary to use a lawn tube with an anchor inserted into it. Lawn tubes are about 18" long with an outside diameter of 1". They have an inside diameter of ¾" to accommodate an anchor body.

To install a lawn tube:

- Because some masonry materials will crack when drilled, drilling a test piece prior to installing an anchor is suggested. If the material does not tolerate this process, locate the hole at the intersection of two or more pieces. Mark the intended anchor position and drill a 1" diameter hole into the material. If the masonry materials are set on a concrete slab, drill completely through the slab. A core drill works well on fragile or brittle materials.
- Lawn tubes are supplied with an anchor and insert as an assembled unit. Use a block of wood and mallet to tap the tube into the hole until its flush with the deck surface.
- Remove the insert, lubricate it and screw it into the anchor body until only the unthreaded portion is exposed. Attach springs as instructed.

It is important to note that this system may also be used in stable soil on which fixed decking is not installed.

Wood Decks

Anchor bodies for wood decks have flanges that are 1.5" in diameter by 1/8" thick. Each flange has countersunk holes to accommodate wood screws. To install wood deck anchors:

1. Countersink a 1.5" diameter hole into the deck 1/8" deep.
2. Drill a 3/4" diameter hole into the center of first hole and to the same depth as or slightly more than length of the anchor body.
3. Vacuum dust and chips from the hole and surrounding area, insert the anchor body and tap it flush with the deck surface.
4. Install the screws and thread a lubricated insert into the anchor body until only the unthreaded portion is exposed.

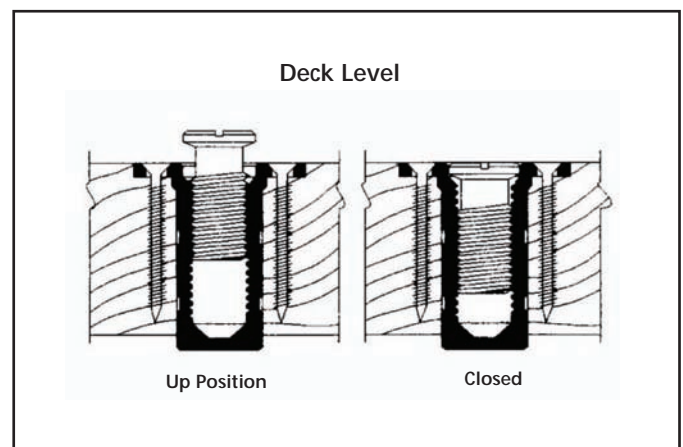

WARNING

AVOID DROWNING RISK

- Remove Standing Water—child can drown on top of cover. (Stay off cover.)
- Remove cover(s) completely before entry of bathers—entrapment possible.
- Non-secured or improperly secured covers are a hazard.
- Failure to follow all instructions may result in injury or drowning.
- Inspect cover annually for damage—do not use if damaged.

MEETS OR EXCEEDS STANDARD PERFORMANCE SPECIFICATION SET FORTH IN ASTM: F1346-91-2003
MANUAL SAFETY COVER - MSC

MFG. DATE: _____

SIZE: _____

PN LB623 REVISED: 3/2/10

DATE INSTALLED

MODEL # MSC-M

MSC-S

SERIAL #

Installing Anchors in Pavers, Brick & Stone Surfaces that have a Concrete/Mortar & Compacted Gravel Base

- A 10" Deck Tube with included anchor can be used for paver, brick & stone applications that have a concrete/mortar & compacted gravel sub base (see diagrams below).
- Whenever possible, locate the hole for the Deck Tube at the intersection of two or more paver/stones.
- A 1" dia. rotary hammer core drill bit is suggested to create the desired holes.
- Using a hardwood block and mallet tap the Deck Tube into position.
 - OPTIONAL: Before completely tapping the Deck Tube flush with the deck surface. Leave 1" of the Deck Tube exposed and apply a bead of masonry construction adhesive around the tube. Then complete tapping the Deck Tube flush to the deck, making sure to clean off all excess adhesive. (For a finished look use the brass collar item MH213 on top of the inserted Deck Stake)
- Remove the insert, lubricate it and screw it into the anchor body until only the unthreaded portion is exposed. Attach springs as instructed.

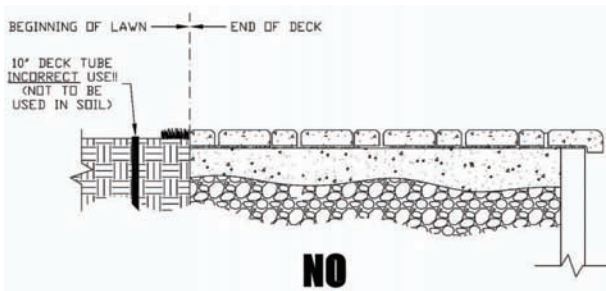
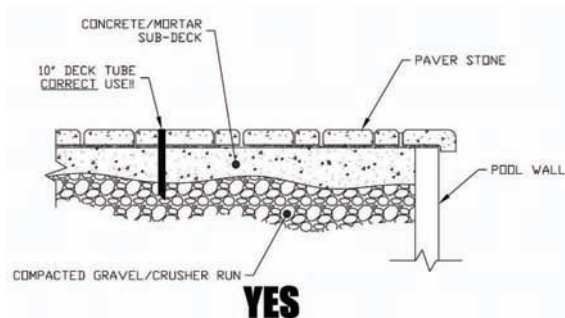

IMPORTANT:

The 10" Deck Tube is not for paver deck applications that do not have a concrete/mortar sub-deck.

Non-Removable Objects and Obstacles

Diving boards, spas, raised walls, planters, rock formations and water falls are among the many pool features that require special arrangements in order to be covered safely.

Coated Stainless Cable and Y-Strap assemblies are available for use when conditions require specific anchoring hardware.



The Coated Stainless Cable assembly includes 2 brass anchors, 2 cable clamps, 1 turn buckle and 15' of coated stainless steel cable. This hardware can be used with spring clips to draw a portion of a safety cover securely around the perimeter of a fixed pool feature. It can also be used in association with expansion anchors, threaded eye bolts and spring clips to create a safe attachment to an object into which expansion anchors can be permanently set.



The Y-Strap assembly is most often used to attach a center length strap to anchors on opposite sides of a diving board stand; though it can be used for other applications. This assembly includes 2 straps sewn to a ring, 2 anchors, 2 D-rings and 2 springs with covers.



Do not install a solid safety cover not equipped with a drain system unless an electric, submersible pump is provided with the cover.

Care and Maintenance

- Cover must be installed taut. Loose-fitting covers can cause excessive abrasion.
- Upon installation of springs, ensure they are taut as they will relax within several weeks.
- Inspect the springs periodically to make sure the springs are properly compressed (about halfway).
- Be sure to maintain the proper chemical levels in the pool during the winter.
- Water level must be within 12" of the cover during the snow season to help support the weight. Failure to do so will void the warranty.
- Read the warranty carefully as to its conditions and make sure the warranty card is completed and mailed to the specified address, or to www.yourpoolwarranty.com
- When installing or removing the cover, make sure not to drag the cover over any abrasive surface and be careful not to catch the cover material on the springs or anchors.
- If pool edging or deck is sharp or abrasive, it is recommended that padding be used to protect the cover in those areas.
- Store the cover in the mesh bag provided and hang off the floor for drainage and protection when not in use.
- Flush out anchor casings with a hose when opening pool and spray the anchor screw with silicone prior to screwing it flush for the pool season.
- **SAFETY IS EVERYONE'S RESPONSIBILITY!** Our safety covers are built to meet or exceed every related safety and structural regulation governing their manufacture. However, it is the consumer purchaser's responsibility to follow all safety instructions provided with any safety cover and to educate all users of the product as to its safe and proper use.

AT NO TIME SHOULD ANYONE PURPOSELY ATTEMPT TO ENTER THE SAFETY COVER.

NOTES



SAFETY COVER INSTALLATION MANUAL

ADDENDUM

August • 2010

Installing Anchors in Pavers, Brick & Stone Surfaces that have a Concrete/Mortar & Compacted Gravel Base

- A 10" Deck Tube with included anchor can be used for paver, brick & stone applications that have a concrete/mortar & compacted gravel sub base (see diagrams below).
- Whenever possible, locate the hole for the Deck Tube at the intersection of two or more paver/stones.
- A 1-1/8" dia. rotary hammer core drill bit (McMaster-Carr #3084A22) is suggested to create the desired holes.
- Using a hardwood block and mallet tap the Deck Tube into position. Before completely tapping the Deck Tube flush with the deck surface. Leave 1" of the Deck Tube exposed and apply a bead of masonry construction adhesive around the tube. Then complete tapping the Deck Tube flush to the deck, making sure to clean off all excess adhesive. (For a finished look use the brass collar item MH213 on top of the inserted Deck Stake)
- Remove the insert, lubricate it and screw it into the anchor body until only the unthreaded portion is exposed. Attach springs as instructed.

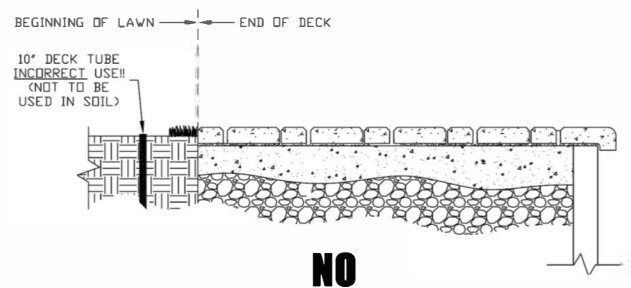
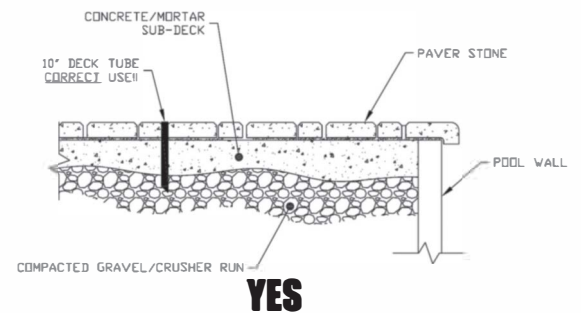

IMPORTANT:

The 10" Deck Tube is not for paver deck applications that do not have a concrete/mortar sub-deck.